

# Tab Secure **SLIM** **WALL MOUNT**

# What's In The Box

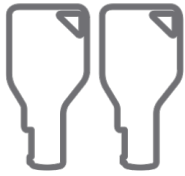

Pair of Keys

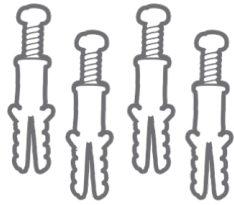

4x Wall Screws



4x Mounting Screws

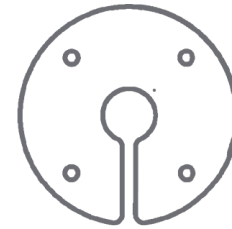

Wall Mount Plate

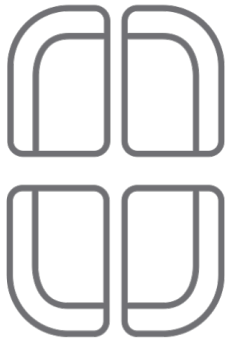
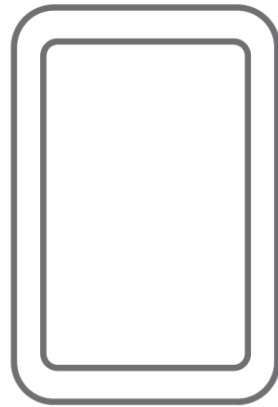
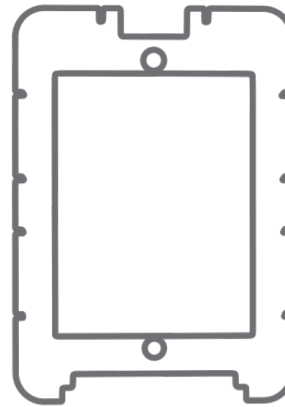

Table Fit Kits



Metal Face Cover



Acrylic Faceplate

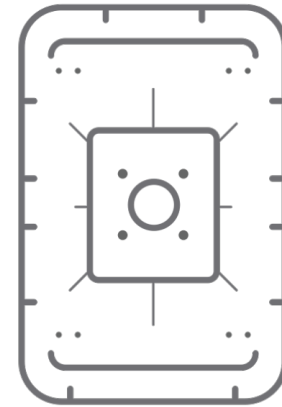

Enclosure

# Dimension Enclosures

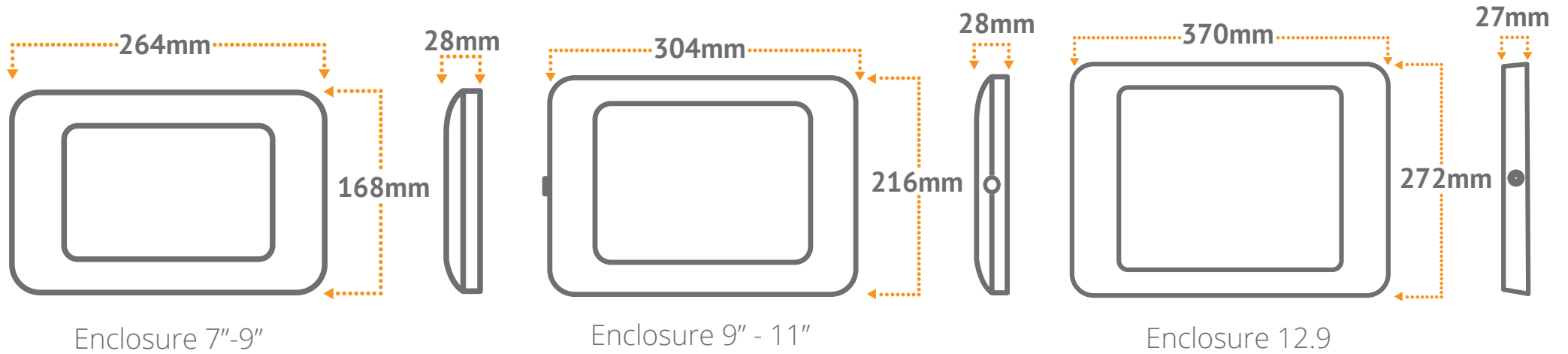

# Installation Guide

## STEP 1: Attach Tab Secure enclosure to wall mount plate.

Remove adhesive backing paper from wall plate.  
Align wall plate on back of enclosure. Ensure slot on wall

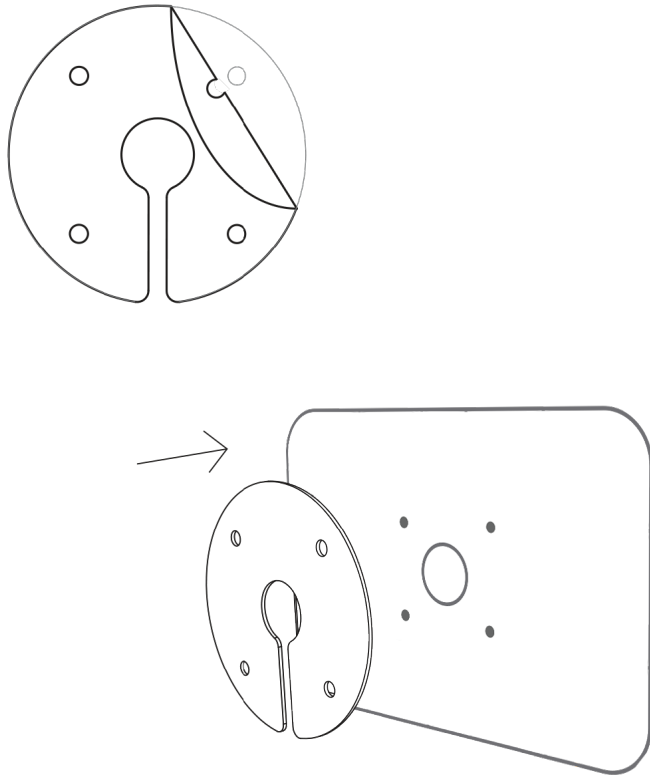

## STEP 2: Feed power cable through back of case

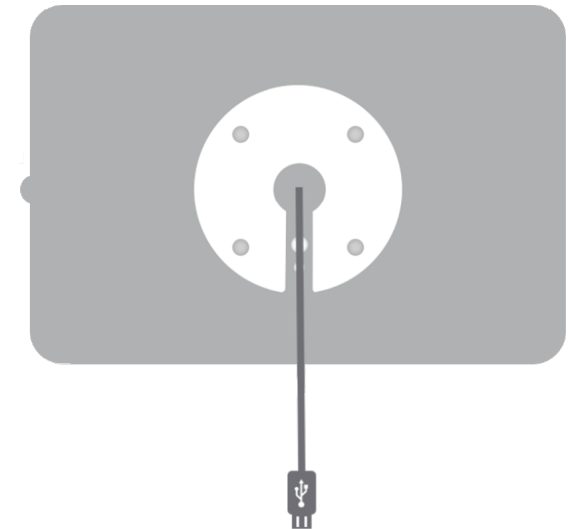

# Installation Guide

## STEP 3: Attach Tab Secure to wall

Use the 4 x self tapping wood screws to fix your Tab Secure to the wall.

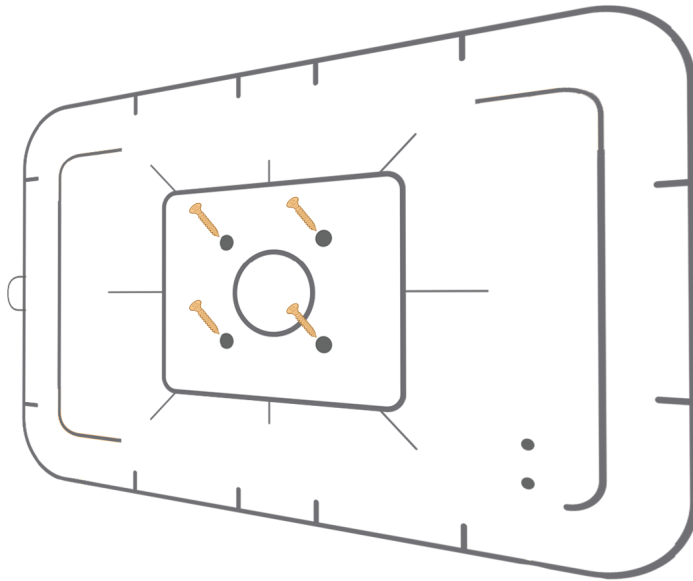

**STEP 4:** Firmly insert each of the four Fit Kit rubber corner pieces into the case by aligning with the Positioning Pins.

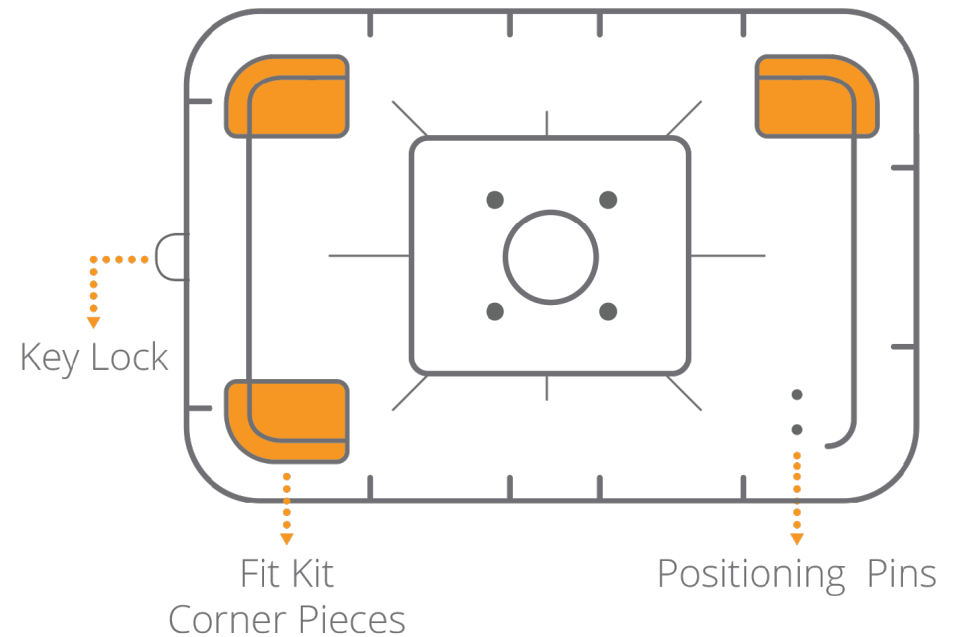

# Insert Ipad or Tablet

**STEP 5:** Connect the charge cable to the tablet, then insert your tablet into the Fit Kit corner pieces. It should sit neat and snug.

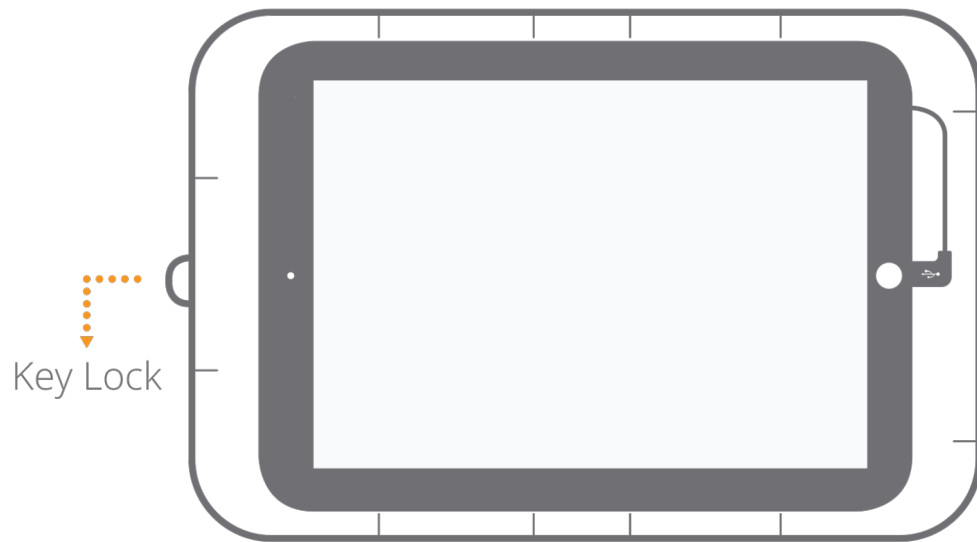

**STEP 6:** First, peel the brown protective seal from one side of the Acrylic Faceplate. Then insert the Acrylic Faceplate over the top of your tablet with the black, shiny side facing up.

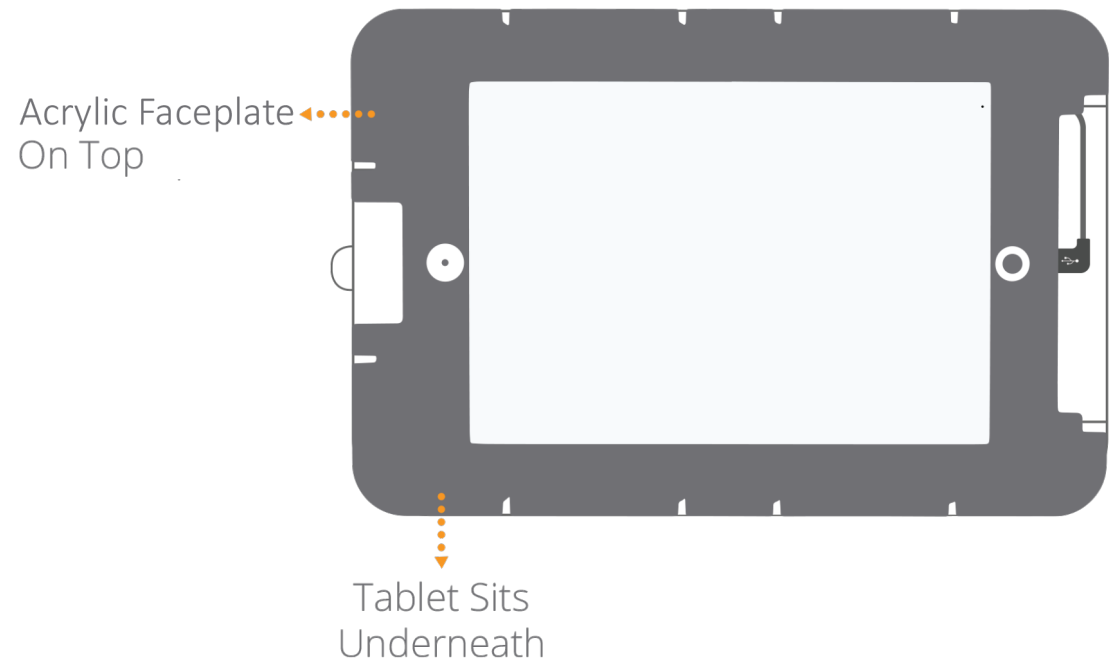

# Attach The Faceplate

**STEP 7:** The last step is to lock-down the Metal Face Cover to secure and protect your tablet. First, position the two Fixing Hooks into the Case (opposite side of the Key Lock). Then pop in the other end. The Faceplate should click into the Case and sit flush.

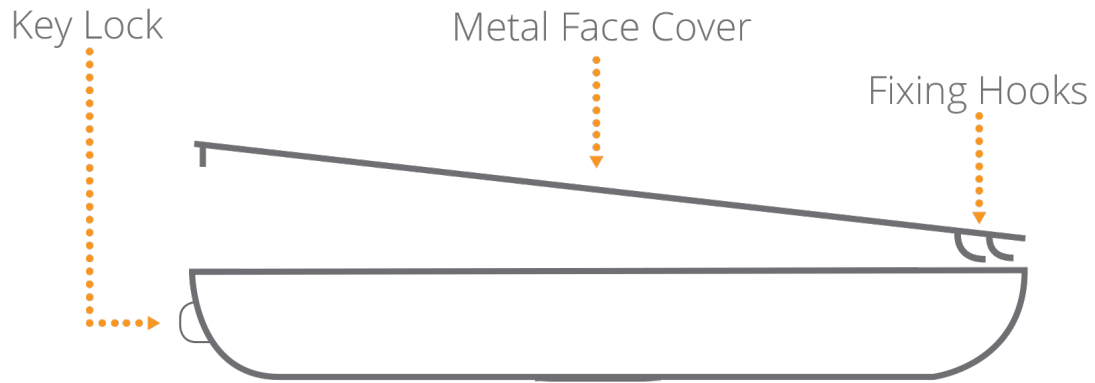

Example

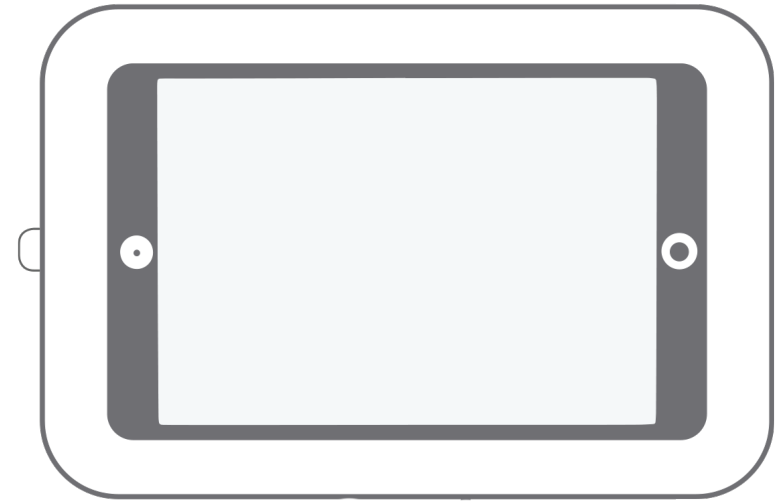

# Push To Lock

**STEP 8:** To complete the setup of your kiosk and ensure your device is secure, make sure to push in the lock-pin. To unlock use the 2 keys provided.

When the lock-pin stands out, it means your kiosk is open

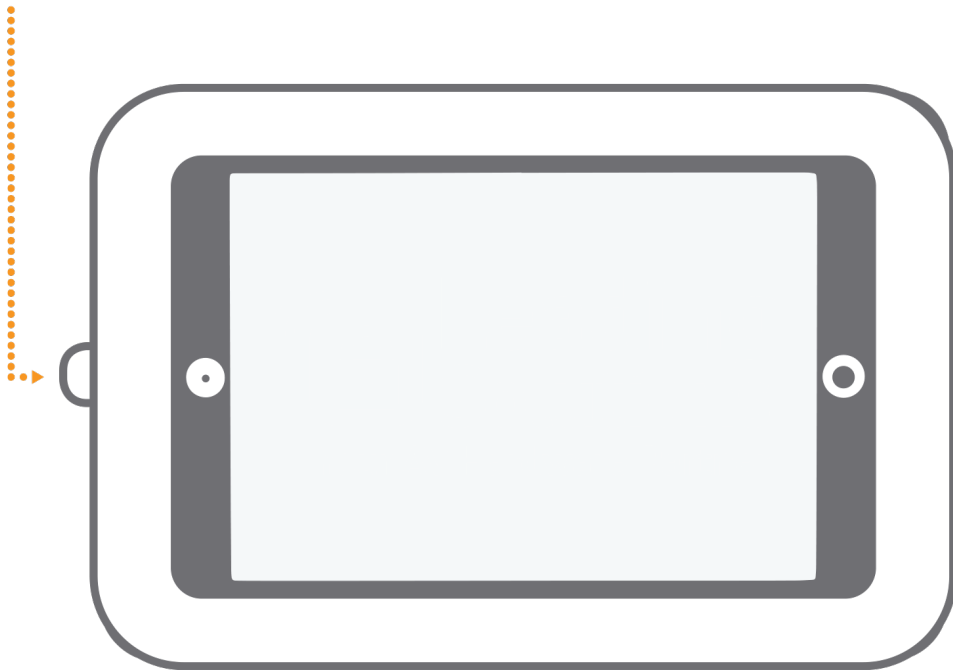

To secure your kiosk, push in the lock-pin

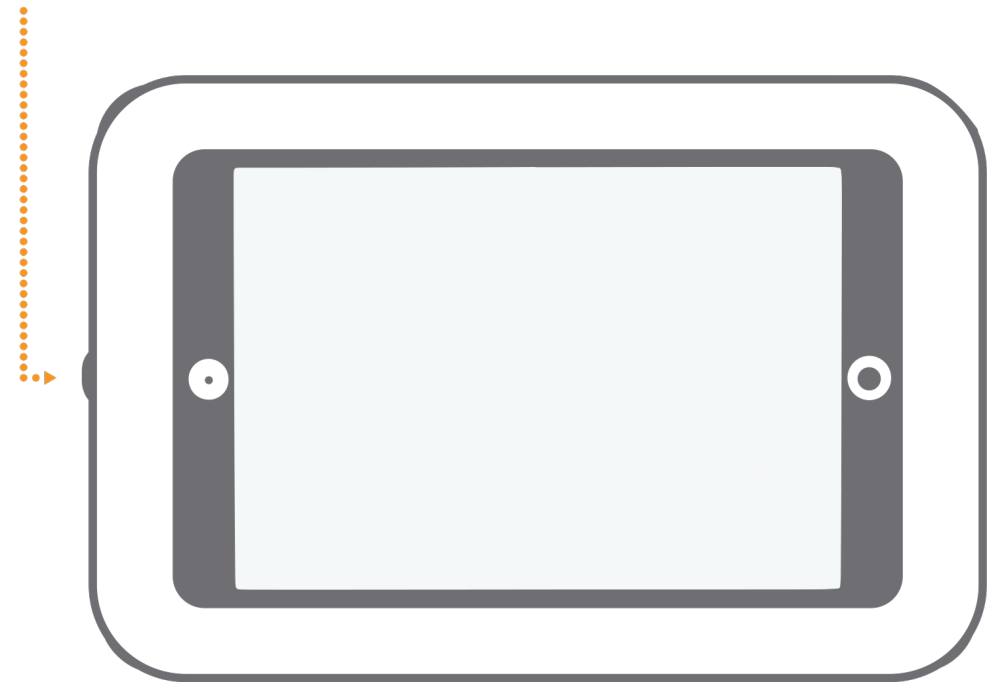

**Please note:** The Pair of Keys are use to unlock the kiosk.

