



Tab Secure

**TABLE TOP
ASSEMBLY**



Tab Secure Desk with Free Standing Base

Secure your tablet in style with the Tab Secure Tablet stands. This Flex mounted solution allows you to mount any tablet on any surface. Help your customers to help themselves when things get busy; put your tablets to work as an engaging tool and let it interact with your clients.

- Internal specific tablet fitting kit.
- Can be mounted in landscape or portrait mode.
- Tamper proof tubular lock with 2 keys.
- Kensington lock point for optional extended security.
- Radio-transparent chassis for Wi-Fi, Bluetooth, 3/4G, and NFC.
- Available in Both Black and White.

Key Features



Secure Enclosure

Each enclosure is secured together by a high quality key and barrel.



Ground Support

Built from strong high grade aluminium alloy to support and secure your tablet.

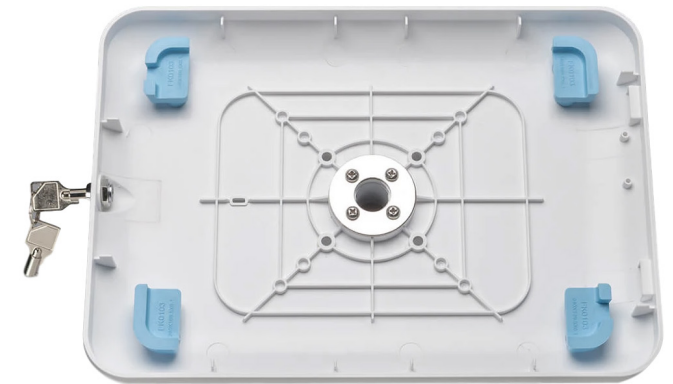

Future Proofing

Easily accommodate new tablet models by replacing the "old" blue rubber kits (and acrylic faceplate).

What's In The Box

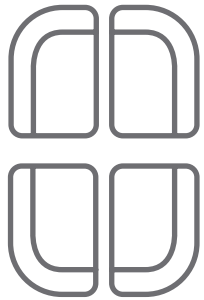
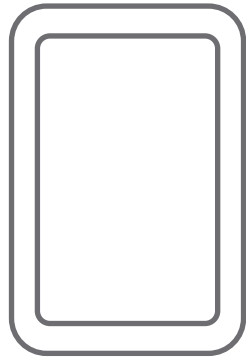
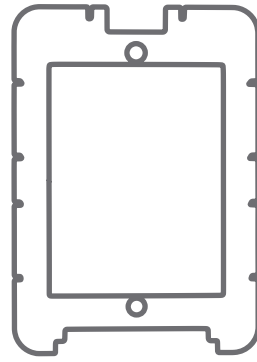

Table Fit Kits



Metal Face Cover



Acrylic Faceplate

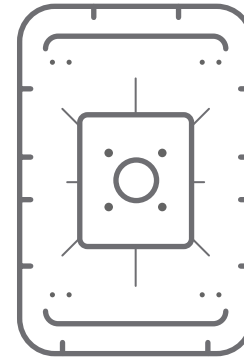

Enclosure

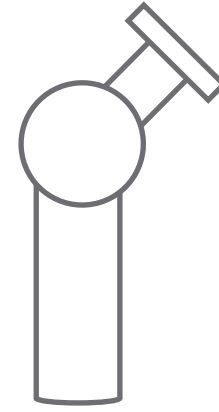

Stalk

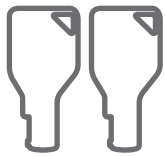

Pair of Keys

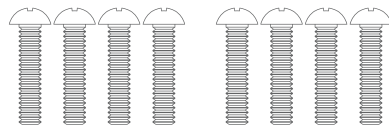

8x Bolts

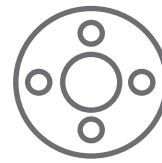

Washer Plate

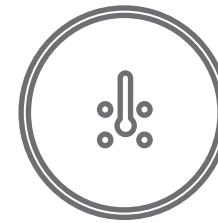

Free Standing Base Plate

Dimension Enclosures

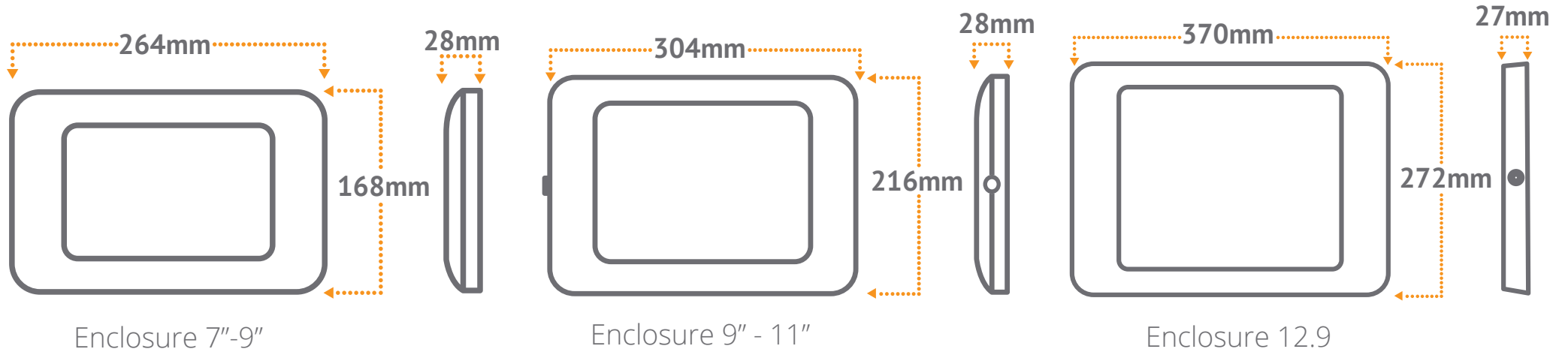

Dimension Free standing Base

The measurements below are for 9-11 enclosures.

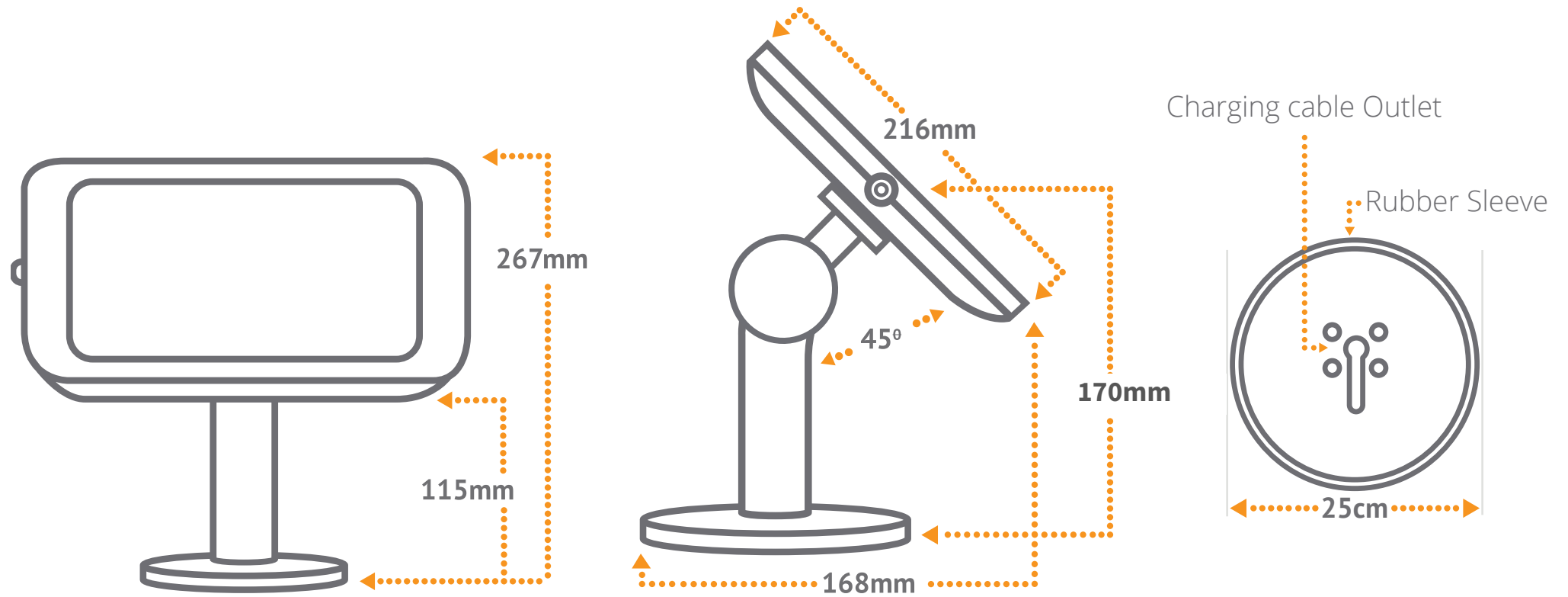

Installation Guide

STEP 1: Attach the Case to the Stem by using the four bolts and the mounting washer to join together.

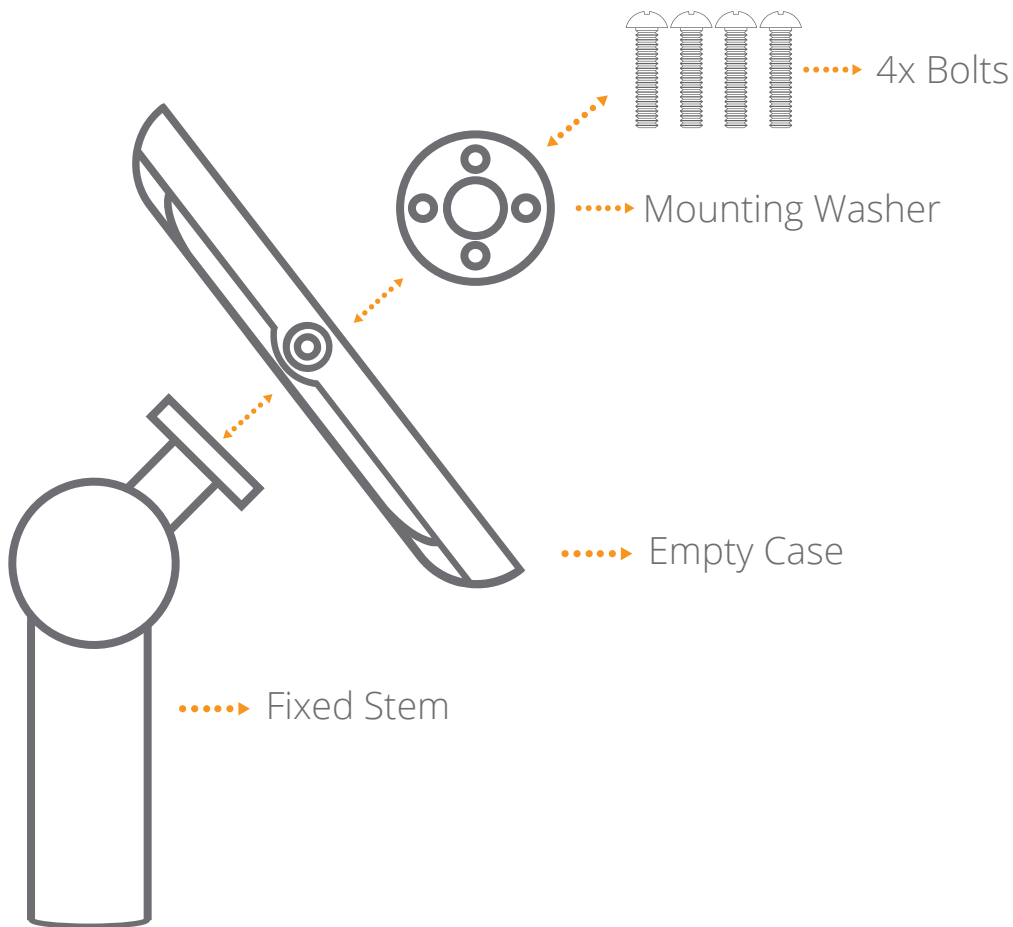

STEP 2: Firmly insert each of the four Fit Kit rubber corner pieces into the case by aligning with the Positioning Pins.

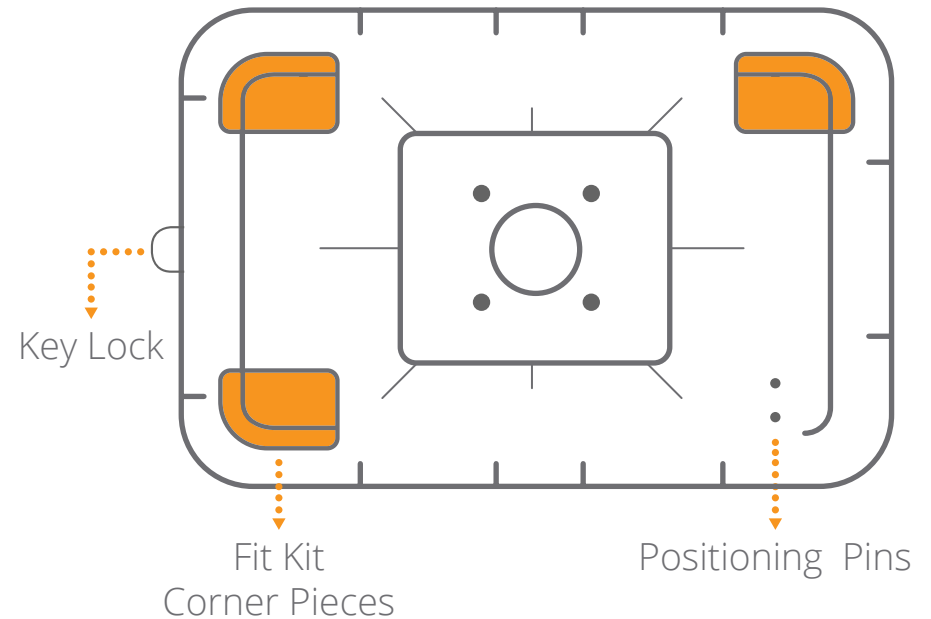

Insert Ipad or Tablet

STEP 1: Connect the charge cable to the tablet, then insert your tablet into the Fit Kit corner pieces. It should sit neat and snug.

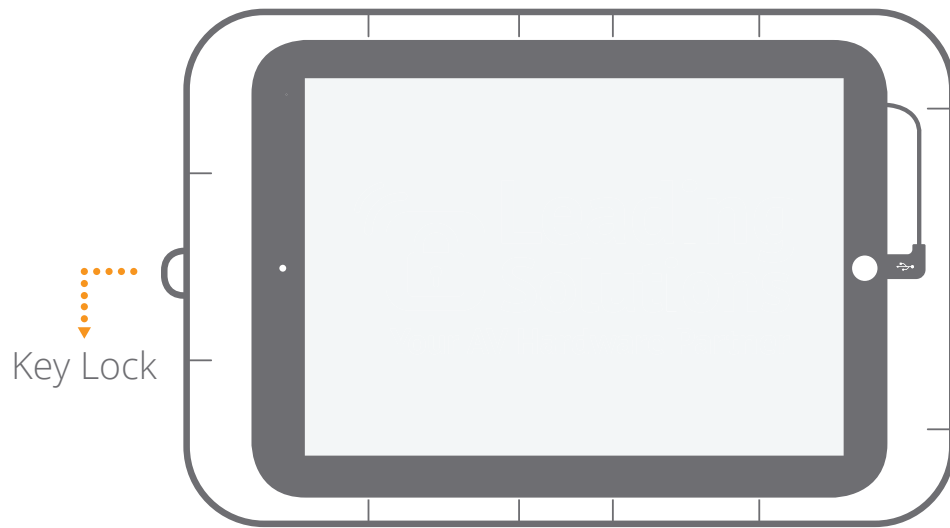

STEP 2: First, peel the brown protective seal from one side of the Access Cover. Then insert the Access Cover over the top of your tablet with the black, shiny side facing up.

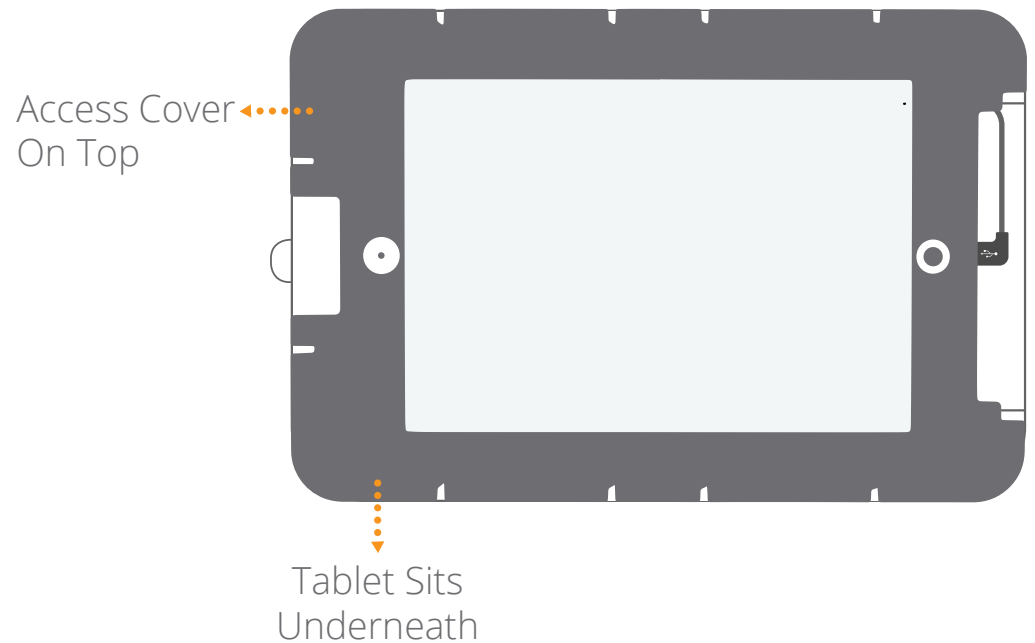

Attach The Faceplate

The last step is to lock-down the Metal Face Cover to secure and protect your tablet. First, position the two Fixing Hooks into the Case (opposite side of the Key Lock). Then pop in the other end. The Faceplate should click into the Case and sit flush.

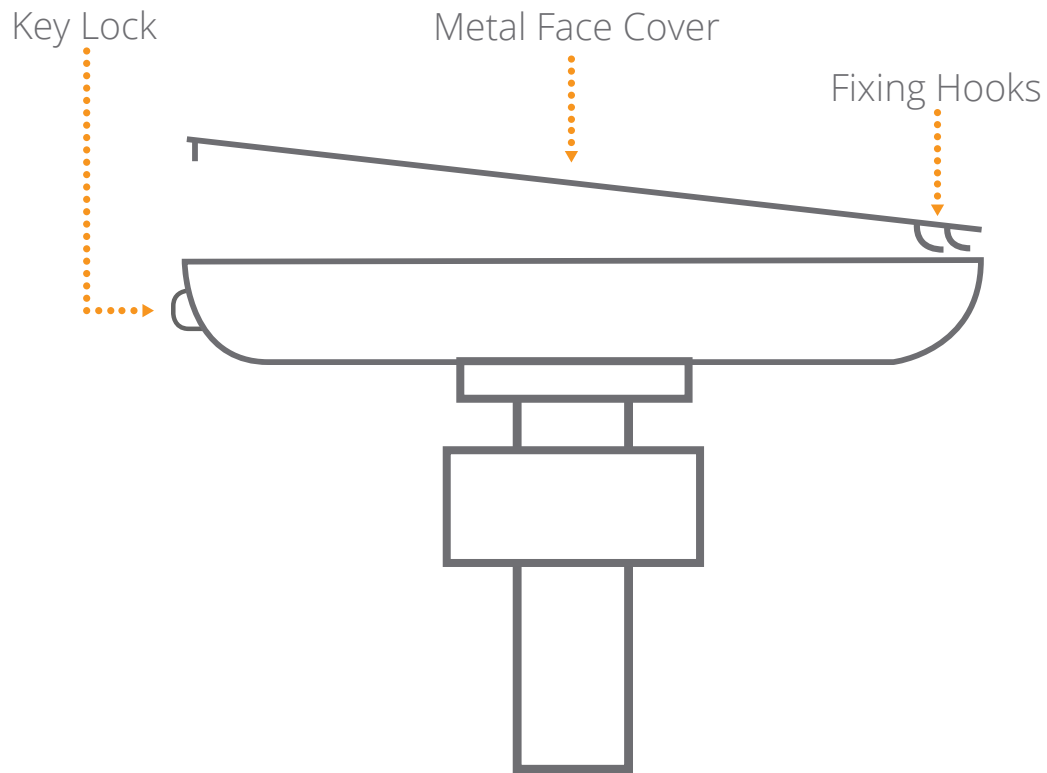

Example

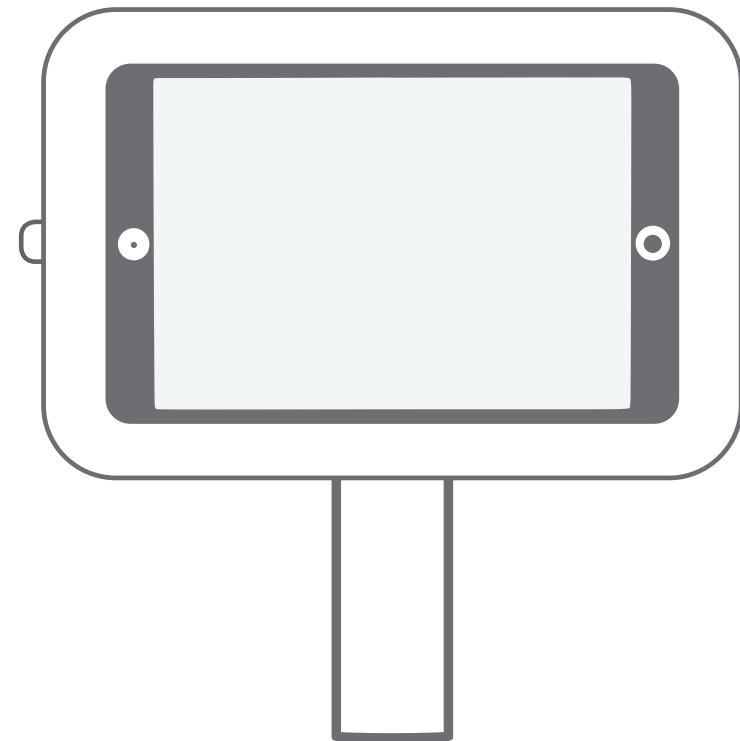

Push To Lock

To complete the setup of your kiosk and ensure your device is secure, make sure to push in the lock-pin. To unlock use the 2 keys provided.

When the lock-pin stands out, it means your kiosk is open

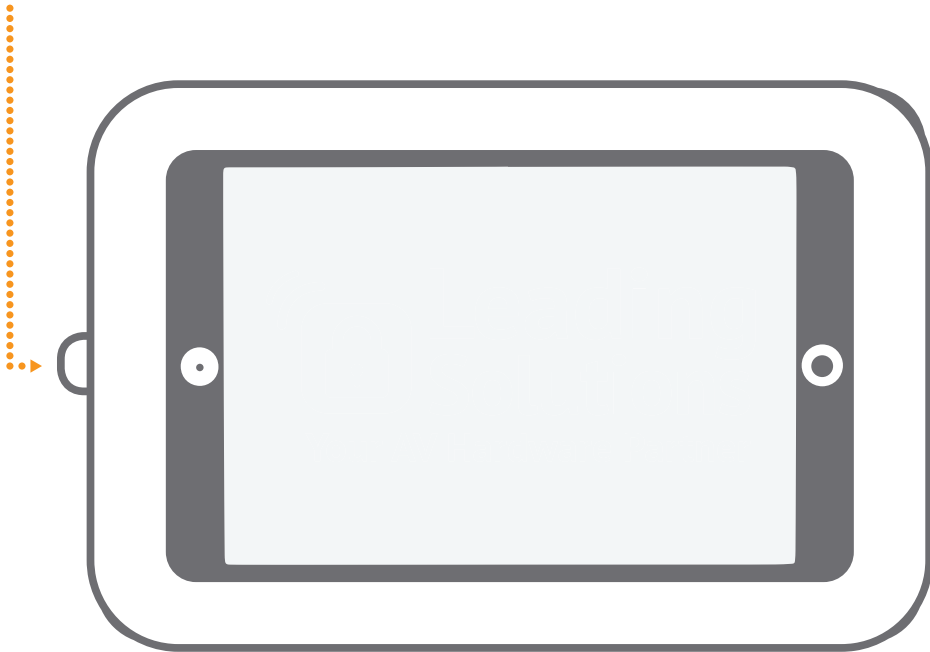

To secure your kiosk, push in the lock-pin

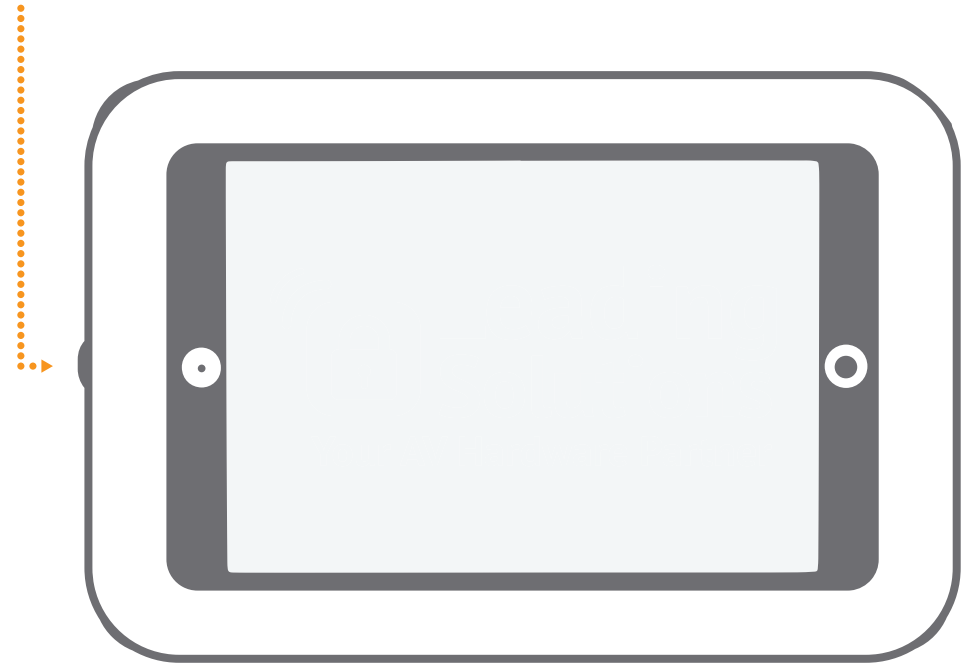

Please note: The Pair of Keys are use to unlock the kiosk.

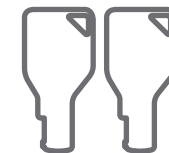

Table Top Power Option

STEP 1:

Route the cable through the stalk. Once the cable is at the desired length connect the free standing base to the stem using the four bolts and tighten from underneath.

